

FORMAS DE RESISTENCIAS CALEFACTORAS BLINDADAS

RECTO

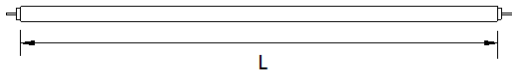

U

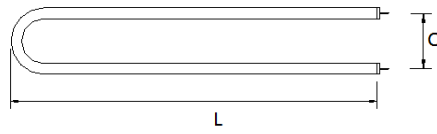

L

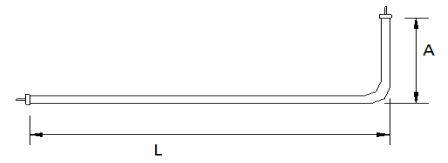

ARCO

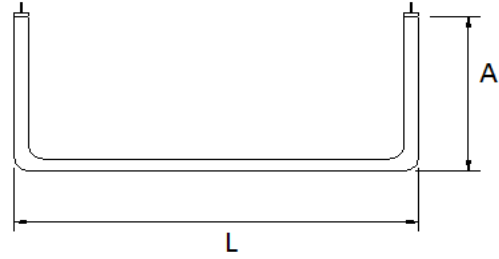

U-L

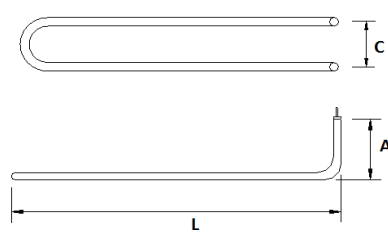

U-U

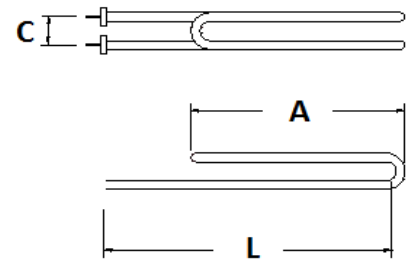

CUADRADA SALIDA HACIA AFUERA

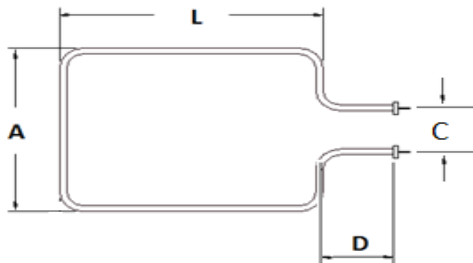

CIRCULAR SALIDA AFUERA

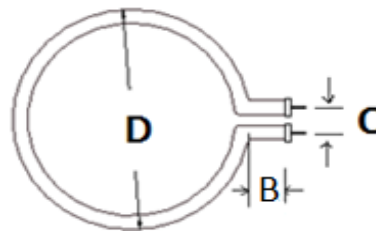

CIRCULAR SALIDA HACIA AFUERA A 90°

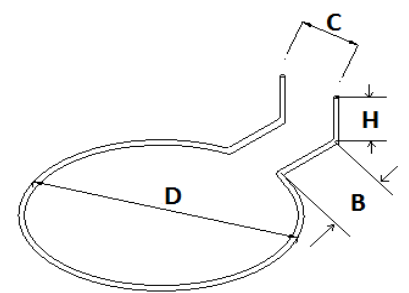

CUADRADA SALIDA HACIA ADENTRO

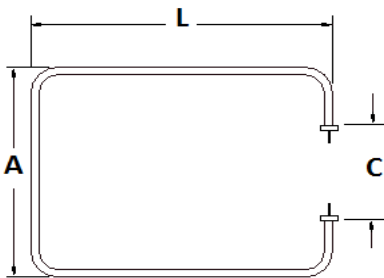

CUADRADA SALIDA HACIA AFUERA A 90°

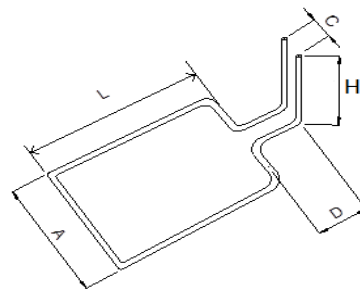

CIRCULAR SALIDA HACIA ADENTRO

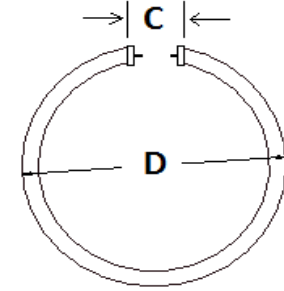

CUADRADA SALIDA HACIA ADENTRO A 90°

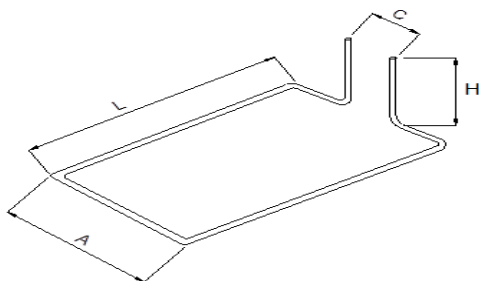

CIRC SALIDA HACIA ADENTRO A 90°

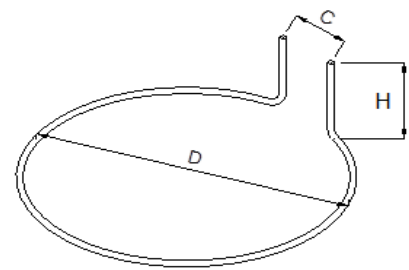

FORMAS DE RESISTENCIAS CALEFACTORAS BLINDADAS

PARRILLA COMÚN

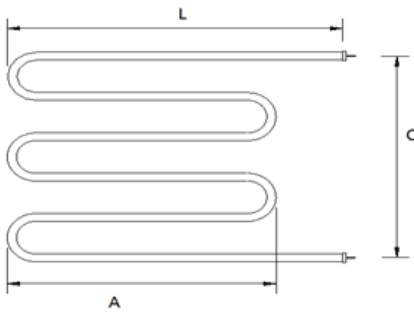

PARRILLA SALIDA HACIA AFUERA

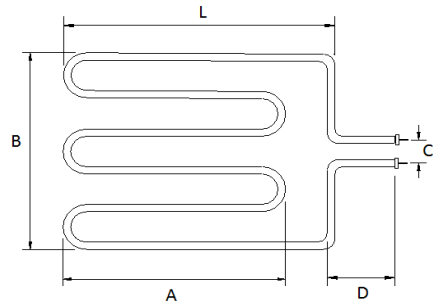

PARRILLA SALIDA HACIA ADENTRO

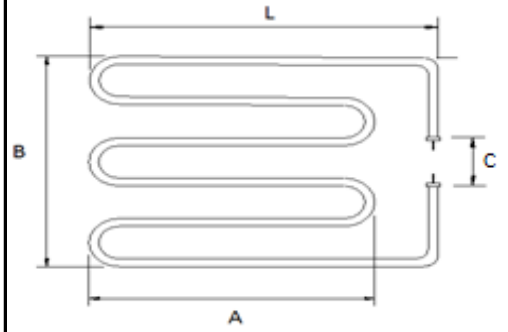

PARRILLA SALIDA LATERAL

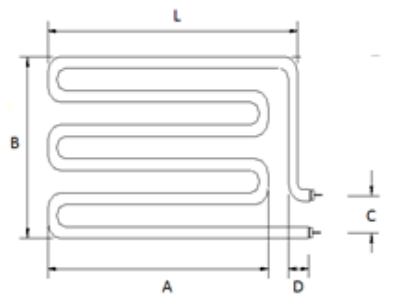

PARRILLA SALIDA HACIA AFUERA A 90°

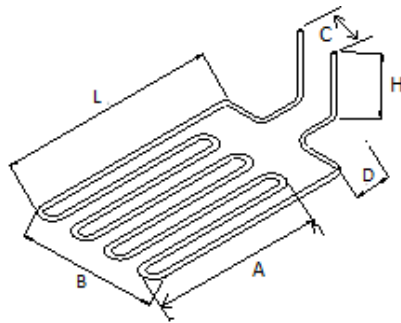

PARRILLA SALIDA HACIA ADENTRO A 90°

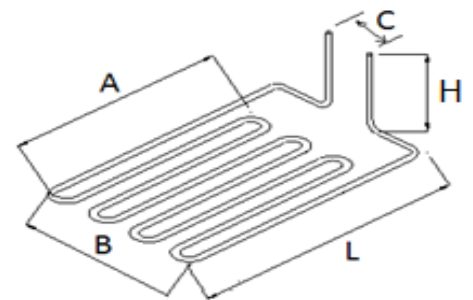

M COMÚN

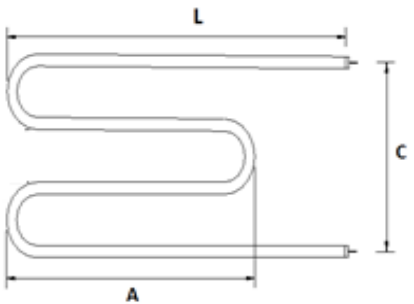

M SALIDA HACIA AFUERA

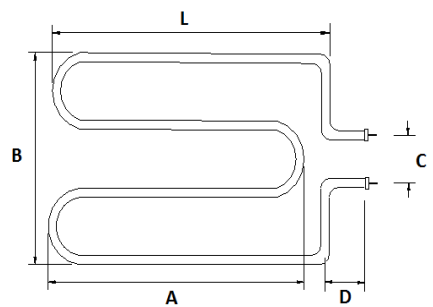

M SALIDA HACIA ADENTRO

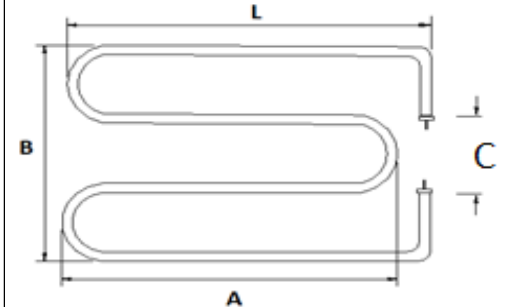

M SALIDA LATERAL

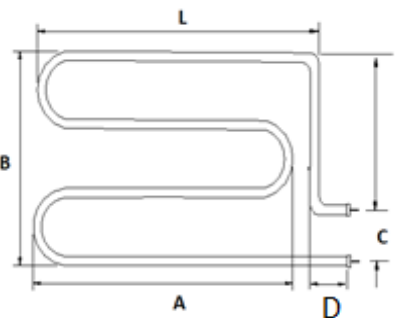

M SALIDA HACIA AFUERA A 90°

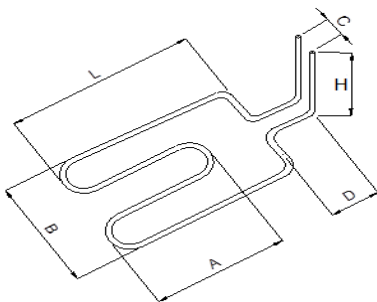

M SALIDA HACIA ADENTRO A 90°

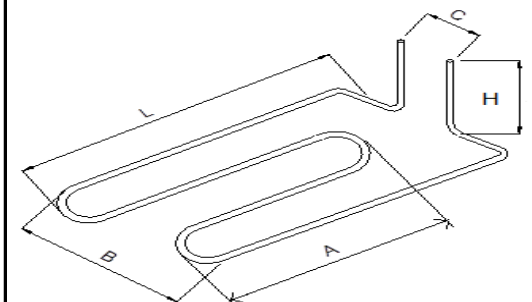

TROMBÓN

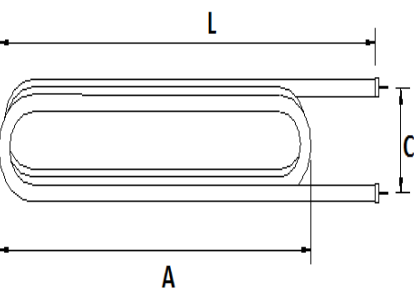

RULO

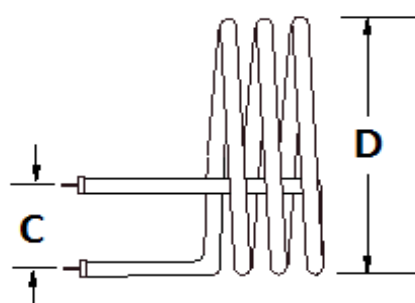

ESPECIALES

A REQUERIMIENTO